

ECB7250 Wall Mounting Template

PN 0535-0133-000

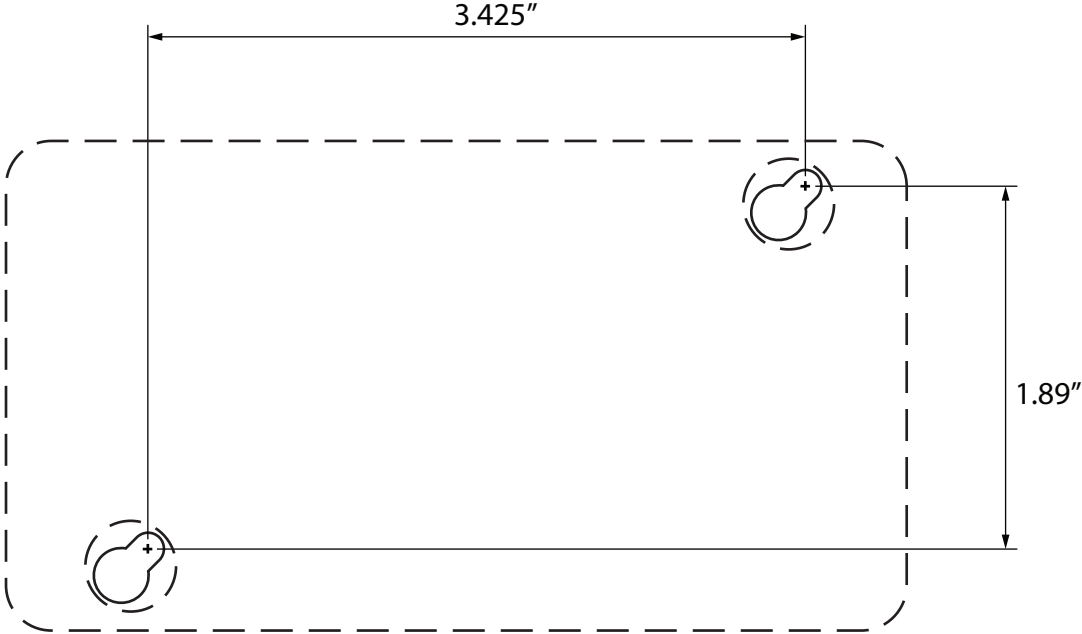

1. Place the template on the wall in the position the network extender will be mounted.
2. Mark the mounting holes. If mounting on wood, drill holes for the screws. If mounting on drywall, drill holes to accept drywall anchors.
3. Leave screws extended about 0.2 inches from the wall.
4. Locate the network extender keyhole openings over the screw heads and push down lightly on the network extender to lock it onto the screws.

Fasteners

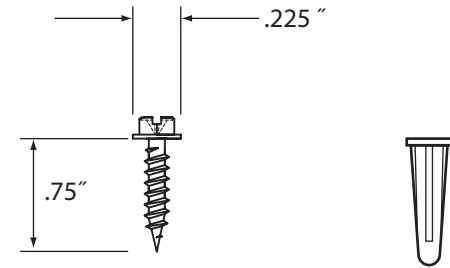

(2) #4 Slotted/Phillip Hex Washer Screws

(2) Plastic Screw Anchors

Illustrations Not to Scale

